

Articulated Forklifts





SET A NEW PACE

WITH THE WIDE RANGE OF GODREJ ARTICULATED FORKLIFTS

When it comes to running your supply chain, everyday is a race to move more product with optimum productivity, efficiency, and safety.

Godrej Articulated Forklifts combine the best of three types of lift trucks.



Speed and flexibility of a counterbalance truck

Lift height of a reach truck

Aisle performance of a VNA turret truck

Godrej Articulated Forklift - One truck that does it all!

A RANGE OF SOLUTIONS

Godrej Articulated Forklifts have capacities from 1.4 to 2 tonnes, lift height up to 12.5 m and battery capacities from 520 to 900 Ah. They offer tailor-made solutions for all your material handling requirements.



1.4 Tonne



1.8 Tonne



2 Tonne



SIMPLIFY TASKS

IN NARROWER AISLES WITH VERSATILE ARTICULATED FORKLIFTS

Capable of working in confined areas with aisle space as less as 1.7 metres.



Less Aisle = More Pallet Postions

MULTIPURPOSE WORKHORSE FOR TOTAL FLEXIBILITY

Transfer from lorry-to-rack and rack-to-lorry in a single handling operation and boost productivity.





GO HIGHER AND NARROWER

WITH UNMATCHED CONFIDENCE



Mast top view



The slim mast in Godrej Articulated Forklifts curbs mast sway, enabling the mast to go higher and be more stable. This makes it possible to handle unprecedented capacities, maximizing pallet locations in your warehouse.



Unmatched visibility and responsive controls on the articulated series let you stack it just right.

More stable than counterbalance forklifts due to its inverted Stability Triangle

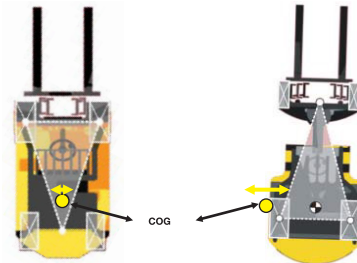

Counterbalance Forklift

Articulated Forklift

The centre of Gravity (CoG) of a forklift must always remain within its 'Stability Triangle'. A forklift becomes unstable when its CoG moves outside the Stability Triangle.

In the Articulated Forklift, the CoG is near the base of the triangle, while in counterbalance trucks, it lies near the narrow apex.



TAKE CONTROL

WITH EXCELLENT ERGONOMICS AND COMFORT FOR THE OPERATOR



Comfortable seat with retractable seat belt



Generous knee and leg room

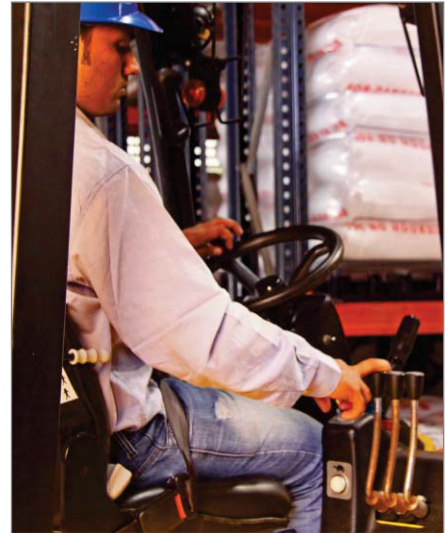

Steering and seating position with all controls within reach

KEEP GOING

WITH PROVEN TECHNOLOGY AND EASY SERVICEABILITY

Comfortable access to critical components ensures that the trucks can be serviced with ease.



Fork pockets for easy removal of battery

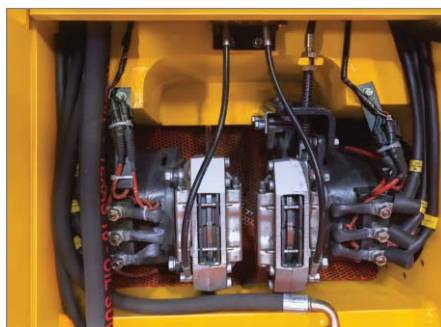

Easy access to AC drive motors

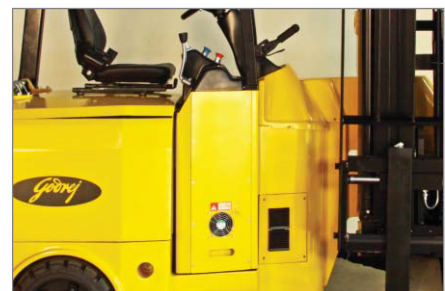

Single allen key required to access control units



STANDARD OFFERINGS

The Godrej Articulated Forklifts come with the following standard fitments to boost productivity:



- | | | |
|----------------|--------------------------------------|---------------------------------|
| 1. Headlights | 6. Horn | 11. Side shift |
| 2. Rear light | 7. Battery Discharge Indicator (BDI) | 12. PU drive tyre(s) |
| 3. Brake light | 8. Emergency stop mushroom button | 13. Solid rear tyres (Smooth) |
| 4. Seat belt | 9. Parking brake | 14. Battery with fork pockets |
| 5. Mirrors | 10. Forks | |



Godrej Articulated Forklifts need about 50% less working aisle width than Counterbalance Forklifts and about 30% less than Reach Trucks.



PERFORMANCE ENHANCING OPTIONS

A wide range of options are available with Godrej Articulated Forklifts to meet your specific application needs.

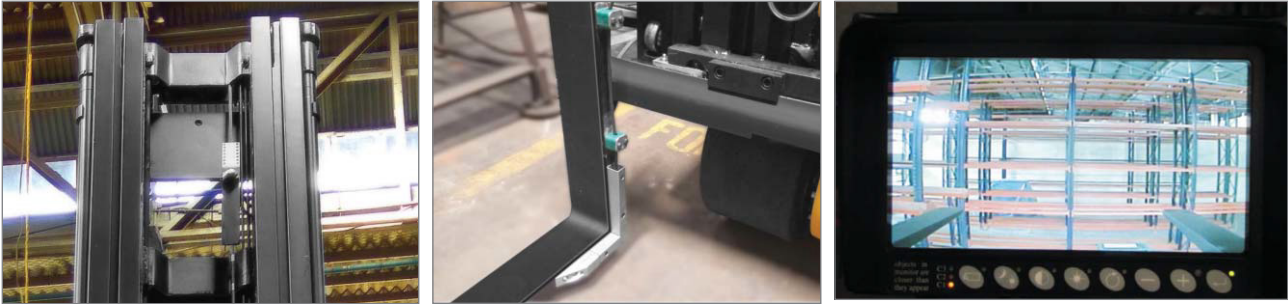

1. Mast / fork mounted camera and colour monitor



2. Biometric access

3. Reverse sensor

4. Impact detector



5. Battery changing rollers and trolley*



6. Auto fill system

- 7. Height restrictions
- 8. Rack assist feature
- 9. Operator Presence Switch (OPS)
- 10. Non-marking tyres (rear wheels only)
- 11. Freezer conditioning
- 12. Blue light
- 13. Fan-For operator

- 14. Load weight indicator
- 15. Overload indicator
- 16. Red halo light
- 17. Extra Head light
- 18. Load back rest
- 19. Reverse travel alarm
- 20. Flashing light

*In lieu of fork pockets.

Technical Data

Parameter			GA 140 E3	GA 180 E3	GA 200 E4	GA 200 E4 HL
Capacity	(kg)		1400	1800	2000	2000
Load centre	(mm)		500	500	500	600
Power source			Traction battery	Traction battery	Traction battery	Traction battery
Service weight (without mast & battery)	(kg)		4835	5070	5340	5900
Travel speed (adjustable) (laden / unladen)	(kph)		11 / 12	11 / 12	12 / 12.5	12 / 12.5
Lift speed (laden / unladen)	(m/s)		0.30 / 0.50	0.30 / 0.50	0.30 / 0.50	0.30 / 0.50
Lower speed (laden / unladen)	(m/s)		0.38 / 0.29	0.38 / 0.29	0.5 / 0.19	0.4 / 0.3
Tilt range (forward / backward)	(deg)		1 / 3	1 / 3	1 / 3	1 / 3
Overhead guard height	(mm)	(g)	2290	2290	2260	2260
Seat height	(mm)	(f)	1220	1220	1220	1220
Cab floor height	(mm)	(e)	700	700	700	700
Minimum ground clearance (rear)	(mm)	(d)	120	120	120	120
Minimum ground clearance (front)	(mm)	(j)	60	60	60	60
Lost load centre	(mm)	(a)	270	270	270	270
Fork dimensions (length x width x thickness)	(mm)		950 / 1150 x 100 x 40		950 / 1150 x 100 x 40	
Overall length to face of forks	(mm)	(c)	2600	2610	2800	2890
Wheelbase	(mm)	(b)	1780	1820	1840	1890
Chassis width	(mm)	(h)	1140	1300	1320	1520
Maximum gradient	(%)	(%)	10	10	15	15
Front chassis articulation angle	(m), (deg)	(m)	± 105	± 105	± 104	+/- 100
Rotation angle	(deg)		210	210	208	200
Lift motor rating	(kW)		12	12	12	12
Drive motor rating	(kW)		8	8	6 x 2	6 x 2
Wheel size (dia x width), (front / rear)	(mm)		406 x 200 / 460 x 180	406 x 180 / 460 x 185	305 x 150 / 4 60 x 200	305 x 150 / 460 x 230
Battery type	(V / Ah)		48 / 520	48 / 650	48 / 720	48 / 900
Min. battery weight	(kg)		899	1068	1369	1503
Control type			MOSFET control with AC induction motor	MOSFET control with AC induction motor	MOSFET control with AC induction motor	MOSFET control with AC induction motor

All dimensions and specifications are subject to variations within ±15%

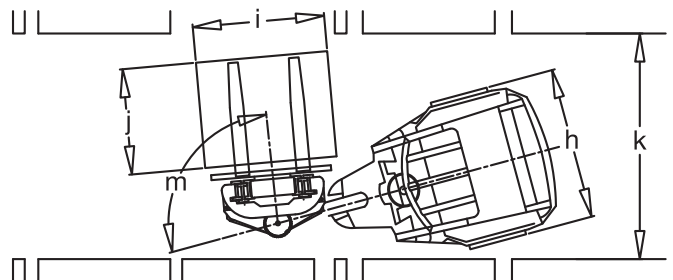
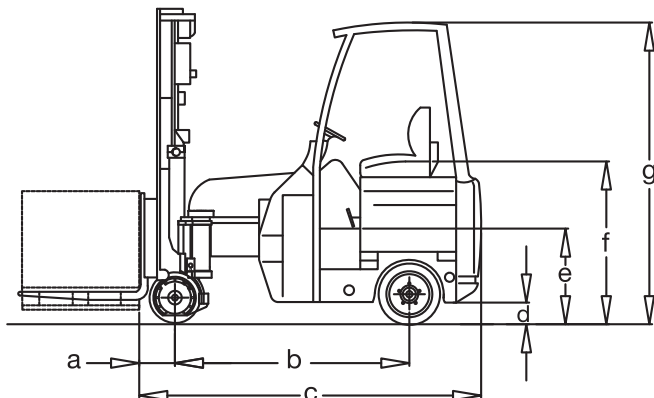



Mast Specifications

Description	Mast Type	Model	Base load capacity (kg) @ load centre (up to 3300 height#)		MFH (mm)	OAHL (mm)	*OAHR (mm) without LBR	**Free lift (mm) without LBR	Derated capacity (kg) at MFH @ load centre (with side-shift)		Std battery (V/Ah)
			500 mm	600 mm					500 mm	600 mm	
Godrej 1.4T-3 Wheel Articulated Forklift Model GA 140 E3	3 STAGE CVT	GA 140-E3-50	1400	1250	5000	2599	5860	1750	1150	1050	48 / 520
	3 STAGE CVT	GA 140-E3-60	1400	1250	6000	2982	6860	2117	1050	900	48 / 520
	3 STAGE CVT	GA 140-E3-71	1400	1250	7150	3466	8010	2550	850	700	48 / 520
Godrej 1.8T-3 Wheel Articulated Forklift Model GA 180 E3	3 STAGE CVT	GA 180 - E3 - 50	1800	1600	5000	2599	5860	1750	1550	1350	48 / 650
	3 STAGE CVT	GA 180 - E3 - 60	1800	1600	6000	2982	6860	2117	1350	1150	48 / 650
	3 STAGE CVT	GA 180 - E3 - 71	1800	1600	7150	3466	8010	2550	1150	950	48 / 650
	3 STAGE CVT	GA 180 - E3 - 82	1800	1600	8200	3949	9060	3083	950	750	48 / 650
	3 STAGE CVT	GA 180 - E3 - 90	1800	1600	9000	4199	9860	3350	800	600	48 / 650
Godrej 2T- 4 Wheel Articulated Forklift Model GA 200 E4	3 STAGE CVT	GA 200 - E4 - 50	2000	1850	5000	2450	5550	1912	1750	1600	48 / 720
	3 STAGE CVT	GA 200 - E4 - 60	2000	1850	6000	2820	6550	2279	1575	1425	48 / 720
	3 STAGE CVT	GA 200 - E4 - 71	2000	1850	7150	3190	7700	2712	1325	1175	48 / 720
	3 STAGE CVT	GA 200 - E4 - 82	2000	1850	8200	3780	8750	3245	1175	1025	48 / 720
	3 STAGE CVT	GA 200 - E4 - 90	2000	1850	9000	4050	9550	3512	1000	850	48 / 720
	3 STAGE CVT	GA 200 - E4 - 94	2000	1850	9400	4180	9960	3633	900	750	48 / 720
	3 STAGE CVT	GA 200 - E4 - 100	2000	1850	10000	4430	10560	3867	825	675	48 / 720
	3 STAGE CVT	GA 200 - E4 - 106	2000	1850	10600	4830	11160	3957	750	600	48 / 720
Godrej 2T- 4 Wheel Articulated Forklift Model GA 200 E4 HL	3 STAGE CVT	GA 200 - E4 - 82 - HL	2000	2000	8200	3785	8750	3147	1550	1400	48 / 900
	3 STAGE CVT	GA 200 - E4 - 90 - HL	2000	2000	9000	4020	9550	3467	1450	1300	48 / 900
	3 STAGE CVT	GA 200 - E4 - 100 - HL	2000	2000	10000	4420	10550	3867	1250	1100	48 / 900
	3 STAGE CVT	GA 200 - E4 - 106 - HL	2000	2000	10600	4660	11150	4107	1125	1000	48 / 900
	3 STAGE CVT	GA 200 - E4 - 110 - HL	2000	2000	11000	4820	11550	4267	1000	900	48 / 900
	3 STAGE CVT	GA 200 - E4 - 120 - HL	2000	2000	12000	5220	12550	4667	750	600	48 / 900
	3 STAGE CVT	GA 200 - E4 - 125 - HL	2000	2000	12500	5420	13060	4867	600	500	48 / 900

Please contact Marketing for customized capacity requirement

*Add 750mm in case LBR is required.

**Subtract 750 mm in case LBR is required.

Aisle requirements:

The minimum clearance required on either side of pallet while in rack should be 100mm.

Length x Width in mm	Min . Clear aisle (k)* GA 140 E3	Min. Clear aisle (k)* GA 180 E3	Min. Clear aisle (k)* GA 200 E4	Min. Clear aisle (k)* GA 200 E4-HL
1200 x 1200 (2 Pallets)	1950 mm	1950 mm	2000 mm	2150 mm
1000 x 1200 (2 Pallets)	1700 mm	1750 mm	1800 mm	1950 mm
1200 x 1000 (2 Pallets)	1850 mm	1850 mm	1900 mm	2050 mm
1200 x 800 (2 Pallets)	1800 mm	1850 mm	1850 mm	2050 mm
1200 x 800 (3 Pallets)	2000 mm	2050 mm	2050 mm	2250 mm
800 x 800 (3 Pallets)	1950 mm	2000 mm	2000 mm	2200 mm
Clear transfer aisle	2700 mm	2700 mm	2700 mm	2850 mm
End transfer aisle	750 mm	750 mm	750 mm	850 mm

Note: The above mentioned aisle spaces are the optimum dimensions (Closed Tolerance) for operating the equipment by trained drivers. An additional clearance of 200 mm is required to facilitate comfortable driving.



VARIOUS FINANCE OPTIONS AVAILABLE

- Equipment finance
- Lease finance
- Rentals



GODREJ & BOYCE MFG. CO. LTD.

Plant 16, Pirojshanagar, Vikhroli, Mumbai 400079

+91 22 7116 4660 • mhemktg@godrej.com • www.godrej.com/intra-logistics

Represented by

Follow us on:



@GodrejMaterialHandling



Godrej Material Handling



godrejmaterialhandling



Godrej Material Handling

BRANCHES

Ahmedabad: 079 6606 0646

Bangalore: 080 6647 2251

Bhubaneswar: 0674 2374 627

Chandigarh: 0172 5012 525

Chennai: 044 6654 4431/32

Coimbatore: 0422 2545 799

Delhi: 011 6650 7348

Guwahati: 03612 468 242

Hyderabad: 040 6643 1203

Indore: 0731 4069 335

Jaipur: 0141 6701 443

Kochi: 0484 6612 777

Kolkata: 033 6601 3771

Lucknow: 0522 6754 980

Mumbai: 022 6976 1725

Pune: 020 6625 5121

Raipur: 0771 6606 606

Vizag: 0891 2746 511

To find out more
about what's new at
Godrej Material Handling,
check out
www.godrej.com/intra-logistics



SC: 04/2023/Rev1